

TOP VIEW

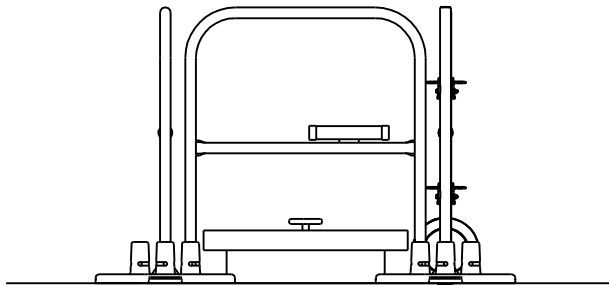

SIDE VIEW

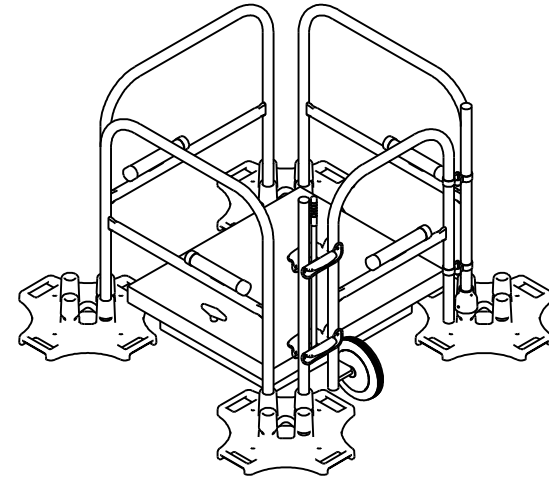
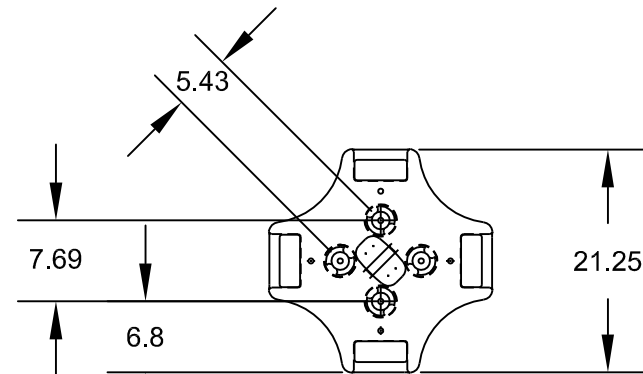

BASE DETAIL

**THIS KIT IS DESIGNED
FOR SIDE EXIT ROOF
HATCHES**

BlueWater Mfg.
P.O.Box 203
7914 Kerber Blvd.
Chanhassen, MN 55317

Tel: 952-926-0515
Toll Free: 866-898-5237
Fax: 952-926-0518
info@bluewater-mfg.com
www.safetyrail2000.com

**Roof Hatch
Safety Rail Kit**

Dwg No.
500097

Rev.
B

Sheet
1/1